



TOPFLYTECH TLW1-4A(E) Vehicle GPS Tracker

User Manual

Revision 1.2

Thanks for your purchasing of the high-quality GPS tracker from TOPFLYTECH. Please read this user manual carefully before installation and operation. Information in this manual is the property of TOPFLYTECH. Changes to the specifications and features in this manual may be made by TOPFLYTECH without prior notice. No part of this manual could be reproduced, copied, translated, transmitted, or published in any form or by any means without TOPFLYTECH's prior written permission.



The tracker is using GNSS & LTE technologies and could collect device coordinates then transfer them via LTE network to the server. It provides customer with cost-effective, efficient and safety management. It has been widely used in commercial transportation, company vehicle fleet management, intelligent transportation, logistics, car rental, engineering machinery, marine transportation and other segments.

Contents

1. QUICK REFERENCE OF CONNECTION DIAGRAM	5
2. PRODUCT SPECIFICATIONS.....	6
3. STANDARD ACCESSORIES INTRODUCTION	7
4. LED INDICATOR.....	7
4.1 NETWORK (RED).....	7
4.2 GNSS (BLUE).....	7
5. INSTALLATION GUIDE	7
5.1 SIM CARD PRE-INSTALLATION NOTE.....	7
5.2 INSTALLATION	7
5.3 RELAY INSTALLATION.....	8
6. CAUTIONS OF TRACKER WIRING	8
6.1 POWER SUPPLY CABLE (REFER TO THE DIAGRAM ON PAGE 5)	8
7. TRACKER CONFIGURATION	8
8. TRACKER OPERATION.....	8
8.1 POWER ON AND OFF	8
8.2 LOCATION SEARCH.....	8
8.3 FUEL SUPPLY CUT	9
8.4 FUEL SUPPLY RESTORE	9
9. QUICK TROUBLE SHOOTING.....	9
9.1 UNABLE TO CONNECT TO THE TRACKING PLATFORM.....	9
9.2 TRACKER SHOWS OFFLINE.....	9
9.3 UNABLE TO LOCATE.....	9
9.4 LOCATION DRIFT.....	9
9.5 NO COMMAND REPLY	10
10. WARRANTY AND STOCK	10
11. FREQUENTLY USED OPERATION COMMANDS (SMS)	10
11.1 APN SETTING	11
11.2 SERVER SETTING.....	11
11.3 UPLOAD INTERVAL SETTING.....	11
11.4 HEARTBEAT SETTING.....	12
11.5 GMT SETTING.....	12
11.6 PIN SETTING	12
11.7 MANAGER SETTING	13
11.8 MANAGER DELETE.....	13
11.9 MANAGER LIST.....	13
11.10 ANTITHEFT SETTING.....	13

11.11	TOWING SETTING.....	14
11.12	SPEED LIMIT SETTING.....	14
11.13	SMS TRACKING MODE SETTING.....	14
11.14	SIM CARD BALANCE CHECKING	15
11.15	RELAY CONTROL (FUEL CUT).....	15
11.16	GOOGLE MAP SEARCH (ALREADY BUILT-IN).....	15
11.17	FORGOT THE PIN.....	15
12.	OPTIONAL ACCESSORIES LIST	15

1. Quick Reference of Connection Diagram

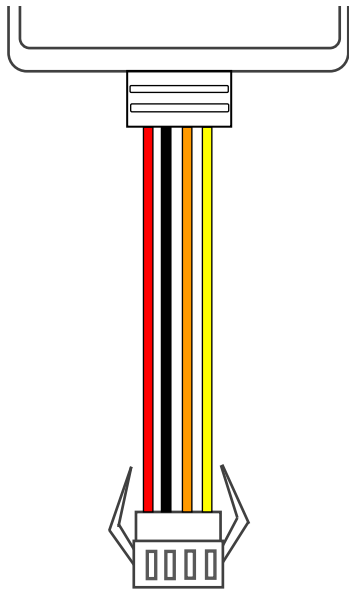

Connector	PIN No.	Color	Function
1	1	Red	Power+
	2	Black	Power-
	3	Orange	Ignition Detection (Digital input1)
	4	Yellow	Relay Control (Digital output1)

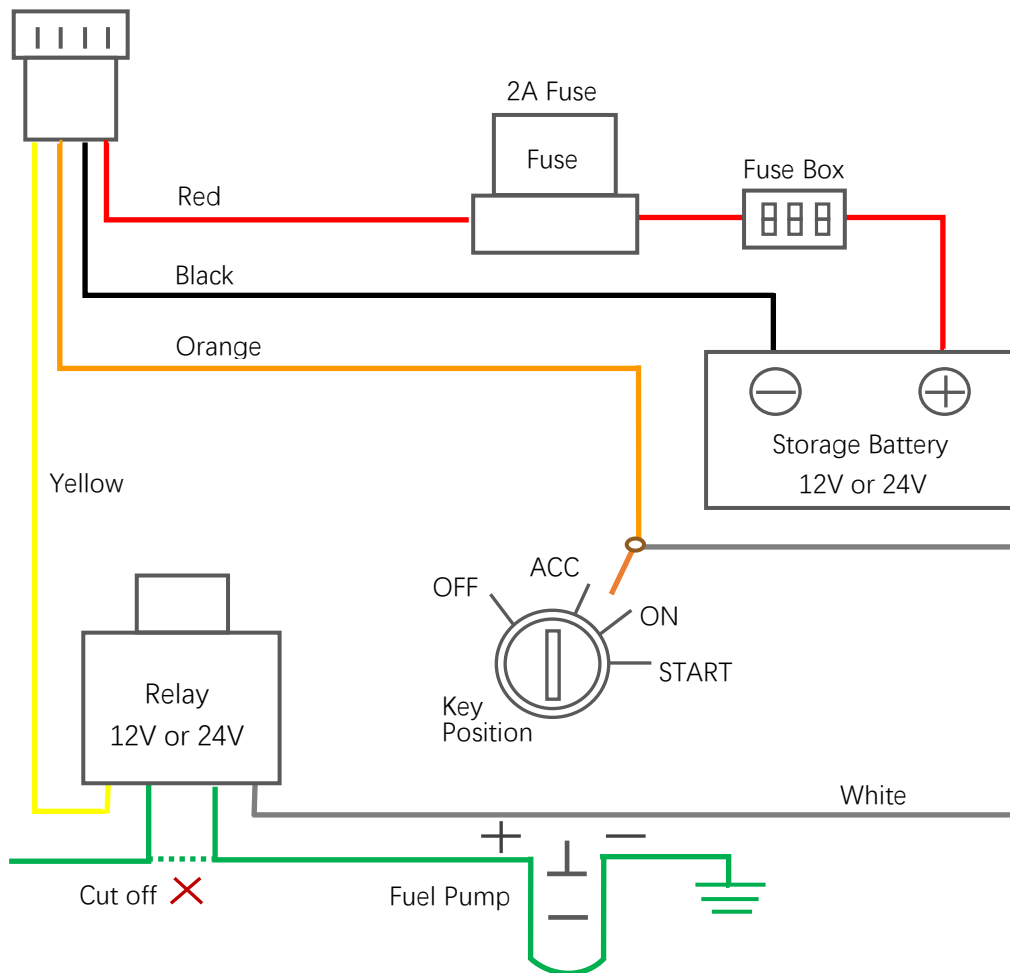

2. Product Specifications

LTE Specifications	
Operating Band	TLW1-4A FDD: B1/B2/B3/B4/B12/B13/B17/B25/B28 TDD: B39 (Cat M1 only)
	TLW1-4E FDD: B1/B2/B3/B4/B5/B8/B18/B19/B20/B26 EGPRS 900/1800MHz
Certification	FCC: B2/B4/B12/B13/B25 (Cat M1)
Data Transmission	eMTC: Max. 300Kbps (DL), Max. 375Kbps (UL) NB1: Max. 32Kbps (DL), Max. 70Kbps (UL) EDGE: Max. 296Kbps (DL), Max. 236.8Kbps (UL) GPRS: Max. 107Kbps (DL), Max. 85.6Kbps (UL)
GNSS Specifications	
GNSS Chipset	Qualcomm Gen 8C GNSS receiver
Parallel GNSS	GPS+Glonass+Galileo+Beidou
Receiver type:	33 tracking / 99 acquisitions- channel GNSS receiver
Sensitivity	Cold start: -149 dBm Tracking: -163 dBm
Position Accuracy in open sky (CEP-50)	< 2m
Standalone TTFF	Cold start: < 29s Warm start: < 27s Hot start: < 1s
Interfaces	
Digital Inputs	1 digital input for ignition detection
Digital Outputs	1 digital output for relay control
LTE/GNSS Antenna	Internal only
Indicator LED	Network and GNSS
FOTA	Yes
BLE (Bluetooth Low Energy)	4.0
General Specifications	
Waterproof	IP66
Dimensions	87mm*35mm*13.5mm
Weight	48g
Backup Battery	Li-Polymer 200 mAh/ 3.7V
Operating Voltage	7V to 32V DC
Operating Temperature	-30°C ~ +80°C (-22°F ~ 176°F)
Storage Temperature	-40°C ~ +85°C (-40°F ~ 185°F)
Air Interface Protocol	
Transmit Protocol	TCP, UDP, MQTT, SMS
Protocol Check & Encryption Support	MD5/ AES256
Scheduled Timing Report	Report position and status at preset intervals

Geo-fence	Geo-fence alarm and parking alarm support up to 64 internal geo-fence regions
Low Power Alarm	Alarm when backup battery is low
Power on Report	Report when the tracker is powered on
Tow Alarm	From internal 3-axis accelerometer
Driving Behavior Monitoring	Aggressive driving behavior detection, e.g. harsh braking and acceleration
Crash Detection	Accident data collection for reconstruction and analysis
Remote Control	OTA control of outputs
Network Signal Jamming Detection	Report network jammer
Data Roaming Control	Avoid additional data consumption

3. Standard Accessories Introduction



Sponge Double-side Adhesive Tape



Power Supply Extension Line

4. LED indicator

4.1 Network (Red) 

Fast Blink	Network Searching
Slow Blink	Network Connected

4.2 GNSS (Blue) 

Fast Blink	Satellite Searching
Slow Blink	Positioned

Note:

- Indicator lights will go out automatically after the tracker turn on for 5 minutes.
- If you want to check the working status, dial the tracker. Then the indicator lights will begin to blink. After 5 minutes, the lights will go out again.
- Slow Blink: Last for 3 second, then go out for 1 second.
Fast Blink: Last for 1 second, then go out for 1 second.

5. Installation Guide

5.1 SIM Card Pre-Installation Note

- 5.1.1 Data service should be enabled.
- 5.1.2 If SIM card is locked via PIN, please unlock it first.
- 5.1.3 Ensure there is sufficient balance in the SIM card.

5.2 Installation

5.2.1 Ask the technician recommended by your dealer to do the installation. Ensure the tracker top side (with TOP SIDE logo on) face upward. Fix the tracker with our standard double-side adhesive tape.

5.2.2 Note:

- 1) Install in hidden location to prevent theft or damage.
- 2) Away from emission source such as all kinds of sensors, burglar alarm and other communication devices.
- 3) There is a sponge double-side adhesive tape as standard accessory for this product. Make sure the destination surface clean, dry and smooth before attaching. The stickiness will be better after 24 hours). Or use wire/cable to fasten the tracker tightly.
- 4) Tracker has built-in antennas. Please ensure the top side (with TOP SIDE logo on) towards to a window (sky) and not shielded by metallic things.

Recommend location:

- Under the plastic cover of console panel behind the front window.
- Beneath the plastic cover of back window.

5.3 Relay Installation

The white cable connects to ACC cable of the car, the yellow cable connects to the relay control cable of the tracker with the same color. Refer to the diagram on page 5.

Note: Check the vehicle battery voltage (usually it's 12V or 24V) and ensure it equal to the working voltage of relay before connecting.

6. Cautions of Tracker Wiring

6.1 Power Supply Cable (Refer to the diagram on page 5)

- 6.1.1 Standard working voltage of the tracker is 7V to 32V DC. Please use the original cables. The red line is +, the black line is -.
- 6.1.2 Orange cable (ACC) connects to the ignition switch of vehicle. Then the tracker will know the exact status of the vehicle.
- 6.1.3 The yellow cable connects to the cable with the same color of the relay. Fasten the relay tightly at a dry place. It is recommended to cover the relay with a plastic bag for protection.

7. Tracker Configuration

Refer to frequently used operation commands in this manual

8. Tracker Operation

8.1 Power on and off

- 8.1.1 Power on: Insert a SIM card and connect the tracker to external power. It will turn on automatically.
- 8.1.2 Power off: Remove the SIM card first, then disconnect the tracker from external power. It will power off automatically around 5~10 seconds.

8.2 Location Search

8.2.1 SMS Query
Send a location inquiry SMS command (refer to the Operation Command in this manual) to the tracker. The location information will be sent to you through SMS.

8.2.2 Platform Query
Connect your tracker to the tracking platform then check the real-time position online. (Additional tracking service charge may happen. Contact with your service provider to get more details.)

8.3 Fuel Supply Cut

Fuel supply cut command can be sent from tracking platform or through SMS when needed. To make sure the vehicle safety, tracker will cut off the fuel supply only when the vehicle is positioned, and the speed is lower than 20Km/H. (If the vehicle speed is higher than 20Km/H or the vehicle isn't positioned, the tracker will return "SET RELAY DELAY, SPEED IS MORE THAN 20KM/H#" or "SET RE-LAY DELAY, GPS UNFIXED#" and will keep monitoring until the vehicle speed is lower than 20Km/H. Then the cut will be triggered and "SET RELAY ENABLE OK, RELAY:1#" will be received.)

8.4 Fuel Supply Restore

Restore command can be sent from tracking platform or through SMS when needed.

9. Quick Trouble Shooting

9.1 Unable to Connect to the Tracking Platform

- 9.1.1 Check the APN and IP settings.
- 9.1.2 Check the SIM card data service whether opened.
- 9.1.3 Make sure there is no limitation or already added server IP to the IP white list when using a M2M SIM card.
- 9.1.4 Check the balance/signal of the SIM card.

9.2 Tracker Shows Offline

- 9.2.1 Check if the vehicle entered network blind area.
- 9.2.2 Check the balance of tracker SIM card.
- 9.2.3 If the connection lost happens on the last several days of the month, check whether the network service is terminated by carrier because of exceeding the max data usage volume.

9.3 Unable to locate

- 9.3.1 Is the top side (with TOP SIDE logo on) facing upwards without shielded by metallic things during the installation?
- 9.3.2 Does the vehicle enter an area with no satellite coverage?

9.4 Location Drift

In an area with poor GNSS signal (like the areas with lots of high buildings), location drift may happen. When move to open area, the drift will no longer exists.

9.5 No Command Reply

- 9.5.1 Check the command format. Make sure it's correct.
- 9.5.2 Vehicle may be in network blind area.
- 9.5.3 Ensure the SIM card is properly inserted.

10. Warranty and Stock

The standard warranty period is 12 months starting from the date of purchasing. If the tracker will be stored for a long time, please connect it to the external power and recharge the internal battery (10 hours) every 3 months. It will be helpful to the internal battery life.

11. Frequently Used Operation Commands (SMS)

Commands are not case-sensitive and can be sent via mobile phone or Web. The content is separated by comma and ends with #. When set successfully, the tracker will return OK and execute it. Otherwise there is no message returned.

Function	Command Format
APN Setting	APN , <i>Current PIN</i> , <i>APN Name</i> , <i>Username</i> , <i>Password</i> #
Server Setting	IP , <i>Current PIN</i> , <i>Server Domain Name or IP</i> , <i>Port Number</i> #
Upload Interval Setting	TIMER , <i>Current PIN</i> , <i>Upload Time(ACC on)</i> : <i>Upload Time(ACC off)</i> : <i>Angle Compensation</i> : <i>Distance Compensation</i> #
Heartbeat Setting	HBT , <i>Current PIN</i> , <i>Heartbeat Interval</i> #
GMT Setting	GMT , <i>Current PIN</i> , <i>Time Zone</i> #
PIN Setting	PASSWORD , <i>Current PIN</i> , <i>New PIN</i> #
Manager Setting	MANAGERA , <i>Current PIN</i> , <i>Manager Code</i> : <i>Manager Phone Number</i> #
Manager Delete	MANAGERD , <i>Current PIN</i> , <i>Manager Code</i> #
Manager List	MANAGERL , <i>Current PIN</i> #
Antitheft Setting	ANTITHEFT , <i>Current PIN</i> , <i>Antitheft Status(On/Off)</i> #
Towing Setting	DRAG , <i>Current PIN</i> , <i>Distance</i> #
Speed Limit Setting	SPEED , <i>Current PIN</i> , <i>Upper Speed Limit</i> #
SMS Tracking Mode	TRACK , <i>Current PIN</i> , <i>SMS Tracking Time</i> #
SIM Card Balance Checking	FORWARD , <i>Current PIN</i> , <i>Service Center Number</i> , <i>SIM Card Credit Checking Command</i> #
Relay Control (Fuel Cut)	RELAY , <i>Current PIN</i> , <i>Relay Status(On/Off)</i> #

Google Map Search	GOOGLE , <i>Current PIN</i> #
Forgot the PIN	MYSELF #

11.1 APN Setting

APN,*Current PIN,APN Name,Username,Password*#

APN Name:

Range: APN of service provider

Length Limit: 1~32

Username:

Range: Letters and Numerals

Length Limit: 0~32

Password:

Range: Letters and Numerals

Length Limit: 0~32

Note:

- 1) Tracker will return "SET APN OK" when received this command.
- 2) If there is no Username and Password, the SMS setting is:
APN,Current PIN,APN Name,,#
- 3) If there is no APN PIN, the SMS setting is:
APN,Current PIN,APN Name,Username,#

11.2 Server Setting

IP,*Current PIN,Server Domain Name or IP,Port Number*#

Server Domain Name or IP:

Range: Letters, Numerals and Symbols

Length Limit: 1~128

Port Number:

Range: Positive Integer

Length Limit: 0~65535

Note: Tracker will return "SET IP OK" when received this command.

11.3 Upload Interval Setting

TIMER,*Current PIN,Upload Time(ACC on):Upload Time(ACC off):Angle Compensation:Distance Compensation*#

Upload Time (ACC on):

Range: Positive Integer

Range Limit: 3~65535

Default: 25

Upload Time (ACC off):

Range: Positive Integer

Range Limit: 0~65535

Default: 600

Angle Compensation:

Range: Positive Integer

Range Limit: 0~90 degrees

Default: 30 degrees

Distance Compensation:

Range: Positive Integer

Range Limit: 0 ~ 65535 meters

Default: 0 meters

Note: Tracker will return "SET TIMER OK" when received this command.

11.4 Heartbeat Setting

HBT,*Current PIN,Heartbeat Interval#***Heartbeat Interval:**

Range: Positive Integer

Range Limit: 0 ~ 255 minutes

Default: 5 minutes

Note: Tracker will return "SET HBT OK" when received this command.

11.5 GMT Setting

GMT,*Current PIN,Time Zone#***Time Zone:**

Range: Floating point

Range Limit: -12.0 ~ 12.0

Default: 8.0

Note: Tracker will return "SET GMT OK" when received this command.

11.6 PIN Setting

PASSWORD,*Current PIN,New PIN#*

PIN:

Range: Letters and Numerals

Length Limit: 1 ~ 10

Default: 0000

Note: Tracker will return "SET PASSWORD OK" when received this command.

11.7 Manager Setting

MANAGERA,*Current PIN,Manager Code:Manager Phone Number#*

Manager Code:

Range: Positive Integer

Range limit: 1~4

Manager Phone Number:

Range: Phone number

Length Limit: 0~40

Default: <Null>

Note:

- 1) Tracker will return "SET MANAGERA OK" when received this command.
- 2) The max manager number is 4

11.8 Manager Delete

MANAGERD,*Current PIN,Manager Code#*

Manager Code:

Range: Positive Integer

Range limit: 1~4

Note: Tracker will return "SET MANAGERD OK" when received this command.

11.9 Manager List

MANAGERL,*Current PIN#*

Note:

- 1) Tracker will return "SET MANAGERL OK" when received this command.
- 2) All the manager phone numbers will be listed.

11.10 Antitheft Setting

ANTITHEFT,*Current PIN,Antitheft Switch(On/Off)#*

Antitheft Switch:

Range: Positive Integer

Range limit: 0 or 1

Default: 0

Note:

- 1) Tracker will return "SET ANTITHEFT OK" when received this command.
- 2) This function is effective only when ACC is off

11.11 Towing Setting

DRAG,*Current PIN,Distance#*

Distance:

Range: Positive Integer

Range limit: 0~65535 meters

Default: 0

Note:

- 1) Tracker will return "SET DRAG OK" when received this command.
- 2) This function will be enabled automatically when ACC is off.
- 3) The Recommended distance setting is no less than 100meters.

11.12 Speed Limit Setting

SPEED,*Current PIN,Upper Speed Limit#*

Upper Speed Limit (KM/H):

Range: Positive Integer

Range limit: 0~32767

Default: 0

Note:

- 1) Tracker will return "SET SPEED OK" when received this command.
- 2) Set "Upper Speed Limit" to 0 will turn off speed alarm.

11.13 SMS Tracking Mode Setting

TRACK,*Current PIN,SMS Tracking Time#*

SMS Tacking Time Range:

Range: Positive Integer

Range limit: 0, 1, 2 ~ 65535 Minutes

Default: 0

Note:

- 1) Tracker will return "SET TRACK OK" when received this command.
- 2) 0: Network tracking mode.
- 3) 1: Disable the tracking function. No data will be sent out to the server.
- 4) 2~65535: Time interval of SMS sending to manager phone in SMS tracking mode.

11.14 SIM Card Balance Checking

FORWARD,*Current PIN,Service Center Number,SIM Card Credit Checking Command#*

Note:

- 1) Tracker will return "SET FORWARD OK" when received this command.
- 2) Then it will return the SIM card balance result.

11.15 Relay Control (Fuel Cut)

RELAY,*Current PIN,Relay Status(On/Off)#*

Relay Status:

Range: Positive Integer

Range limit: 0(Restore) or 1(Cut)

Default: 0

Note:

- 1) In order to ensure the vehicle safety, we set the speed threshold at 20KM/H.
- 2) If the vehicle speed is higher than 20KM/H or the vehicle isn't positioned, the tracker will return "SET RELAY DELAY, SPEED IS MORE THAN 20KM/H#" or "SET RELAY DELAY, GPS UNFIXED#" and will keep monitoring until the vehicle speed is lower than 20KM/H. Then the cut will be triggered and "SET RELAY ENABLE OK, RELAY:1#" will be sent.
- 3) If recover the fuel (set to 0), tracker will return "SET RELAY DISABLE OK,RELAY:0#"

11.16 Google Map Search (Already Built-in)

GOOGLE,*Current PIN#*

Note: Tracker will return below message when received this command.

<http://maps.google.com/maps?q=<Latitude>,<Longitude>>

11.17 Forgot the PIN







MYSELF#

Note:

- 1) If the manager phone number has been set, only the manager can use "MYSELF#". If no manager setting, the tracker will return the IMEI and current PIN when it received "MYSELF#" from any mobile phone.
- 2) This command can be used to retrieve password.

12. Optional Accessories List

Product Sku	Description	Photo for Reference
-------------	-------------	---------------------

TA01	Fuel Supply Cut Relay(12V)	
TA11	Fuel Supply Cut Relay(24V)	
TA12	BLE Tag	
TA19	External TPS (BLE)	
TA20	External TPS Suite (BLE)	
TA21	Internal TPS (BLE)	
TA22	Internal TPS Suite (BLE)	